

Calinor EVO

Calinor EVO Floodlight PIR Cool White 30W Black
Code: ACAE30/1/CW/B/PIR

Category	Floodlights
Application	Commercial, Industrial, Outdoor, Retail
Specification	Performance

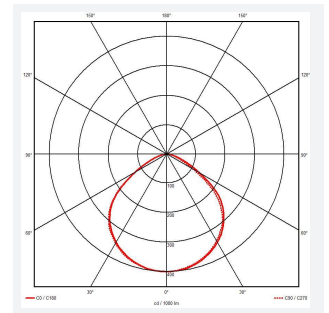
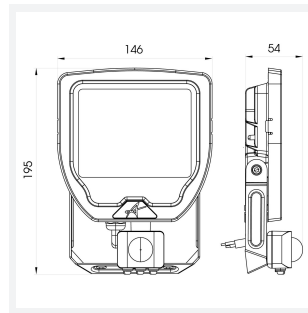
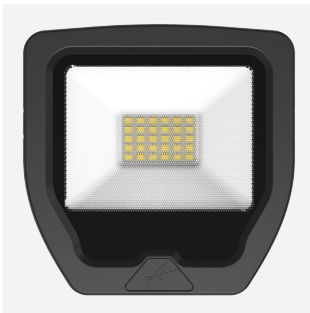

PRODUCT FEATURES

- Compact, slim and robust designed LED floodlight suitable for residential and commercial applications
- Toughened microprism glass for visual comfort, uniformity and durability
- Pre-wired with 1 metre of rubber insulated cable for ease of installation and easy integration with Floodbox accessory
- Polycarbonate spike accessory allowing installation into lawn and garden applications
- Polycarbonate front trim provides excellent corrosion resistance
- Bracket design allows installation without removing mounting bracket
- Breather gland acts to minimise risk of water ingress
- PIR versions complete with manual override facility

GENERAL INFORMATION	
Wattage	30W
Lumens Delivered	3300lm
Lm/W	110lm/w
Beam Angle	100
CRI	80
CCT	4000K
Input	220/240V
Operating Temp	-15°C - 40°C
SDCM	6
Energy efficiency class	D

TECHNICAL INFORMATION	
Light Source	LED
Colour / Finish	Black
IP Rating	IP65
Class Protection	1
Internal / External	External
Surface / Recessed / Suspended	Surface
Lumen Depreciation	L80 69,000h
Warranty (Years)	5
CE Mark	Yes
Height	195 mm

